



PRODUCT DATA SHEET

SEEMLESS STRIP LIGHT SERIES



5 Year Warranty

ETL Intertek 5005268

IP20 NEMA type 1

IP68 NEMA type 6

RoHS COMPLIANT

CE

UL US LISTED (LOW VOLTAGE LUMINAIRE) E86022

Description

Our flexible SSL (Seamless Strip Light) series creates a seamless line of light from start to finish. The all new strip design uses flip chip LED technology to eliminate visible LED dots (hot spots). The all new chip-on-board technology not only improves light quality but also improves thermal management and flexibility of the strip. The smaller LEDs can be packed tighter and weigh much less than the bulkier SMD 3040 or 5050 LEDs, creating a strip that can work in nearly any application. The spotless output makes the SSL ideal for narrow applications like display cases and backlighting, or where reflective surfaces such as granite and tile are used.

Product Features

- LEDs have a High CRI > 90.
- Specification Grade LED Strip with premium 3M™ Adhesive and 3OZ (10 Mil) Copper Weight.
- Highest Quality Components & Fully Dimmable
- 180° Beam Angle.
- SSL (0.39 inch) Width 3 watt Per Foot and 4.4 watt Per Foot .
- Operating Temperature -4°F to +176°F
- 24V DC Input .
- Cutting Increment:
 - Color Balance - Every 1.036"
 - RGB - Every 0.985"
 - Single Color - Every 2.46"
- Single Power Feed Maximum Run Length:
 - 3 watt : 33 FT
 - 4.4 watt : 25 FT

Strip Light Colors

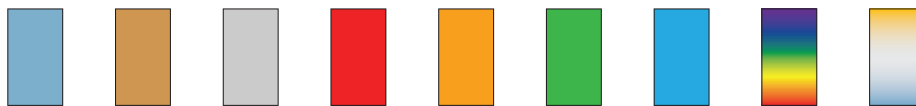

- Warm White 2700K/3000K/3500K
- Natural White 4000K
- Cool White 5000K
- Red 620nm
- Amber 610nm
- Green 520nm
- Blue 455nm
- RGB-Red, Green, Blue(Color Changing)
- Color Balance(Color Tunable) 2700k-6000k

Product Specific Specifications

Model	Length	Watt	Color Temperature	IP Rating	Voltage
SSL	10 FT or 15FT or *(32FT 3W Only)	3W or 4.4W or 6.3W	27K-2700°K or 30K-3000°K or 35K-3500°K or 40K-4000°K or 50K-5000 °K or 60K-6000°K or A-AMBER or B-BLUE or G-GREEN or R-RED	IP65 or IP68	DC 24V
		4.4W	RGB or CCT or D2W		
	15FT	6.3W	RGBCB		

SKU Builder: STP-SSL_length_watt_color temperature_IP rating_voltage EX:STP-SSL-15FT-3W-30K-IP20-12V

Ordering Code

Model	Length	Watt	Color Temperature	IP Rating	Voltage
STP-SSL					24V
STP-SSL	10 FT - 10 ft Reel or 15 FT - 15 ft Reel or *(32 FT - 32 ft Reel 3Watt Only)	3W or *4.4W or *6.3W	27K-2700 or 30K-3000 or 35K-3500 or 40K-4000 or 50K-5000 or 60K-6000 or A-AMBER or G-GREEN or R-RED or B-BLUE or RGB or CCT D2W RGBCB	IP20 or IP68	DC 24V
SKU Builder: STP-SSL_length_watt_color temperature_IP rating_voltage EX:STP-SSL-15FT-3W-30K-IP20-24V					
* RGB and CB is only available as 4.4 watts			* RGBCB is only available as 6.3 watts		

Dimensions

SINGLE COLOR SSL

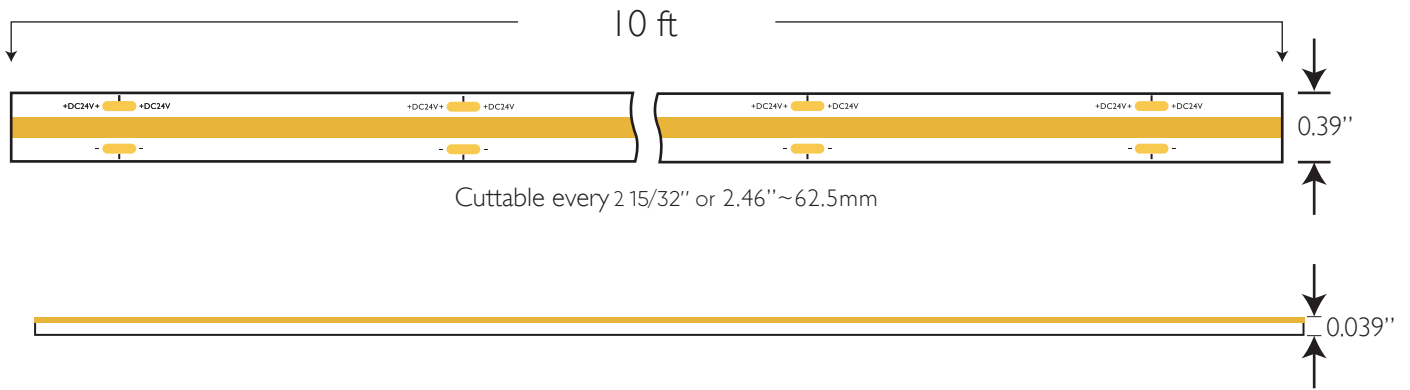

CCT SSL

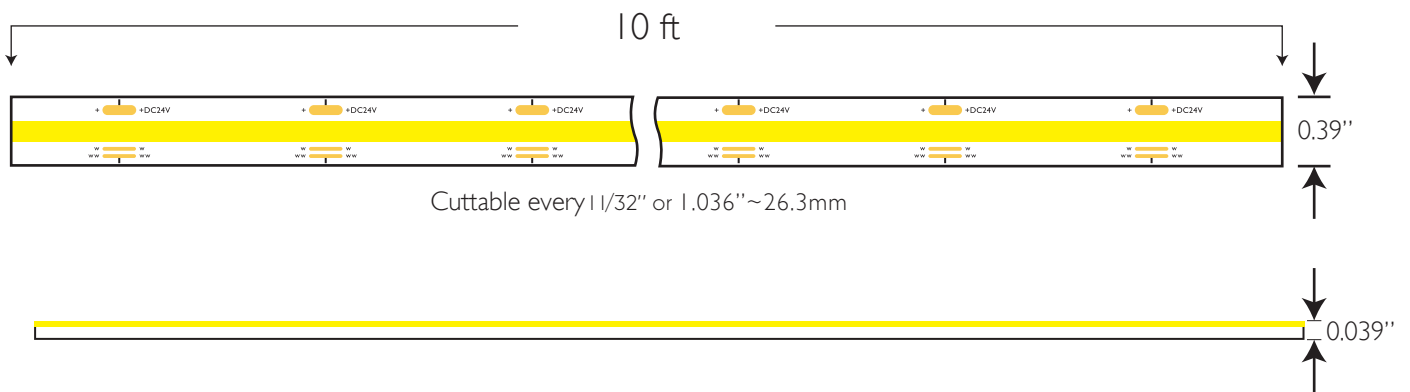

RGB SSL

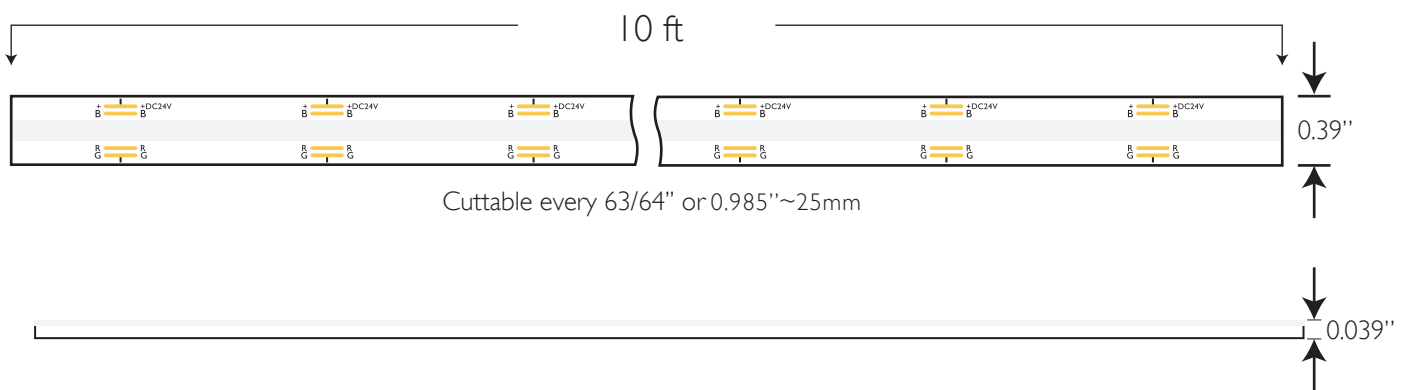

DIM TO WARM SSL

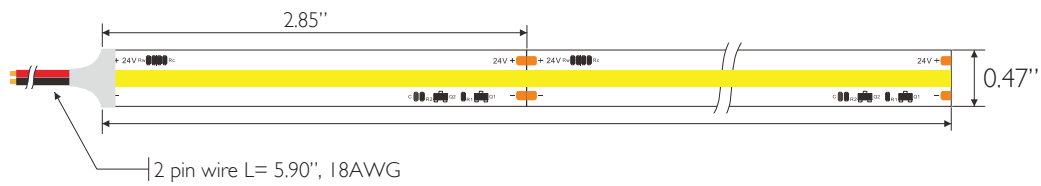

SSL RGBCB

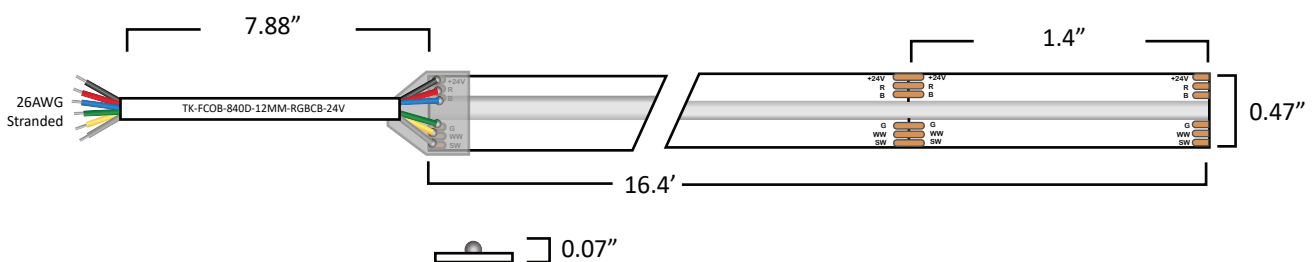

Lumen Per Foot

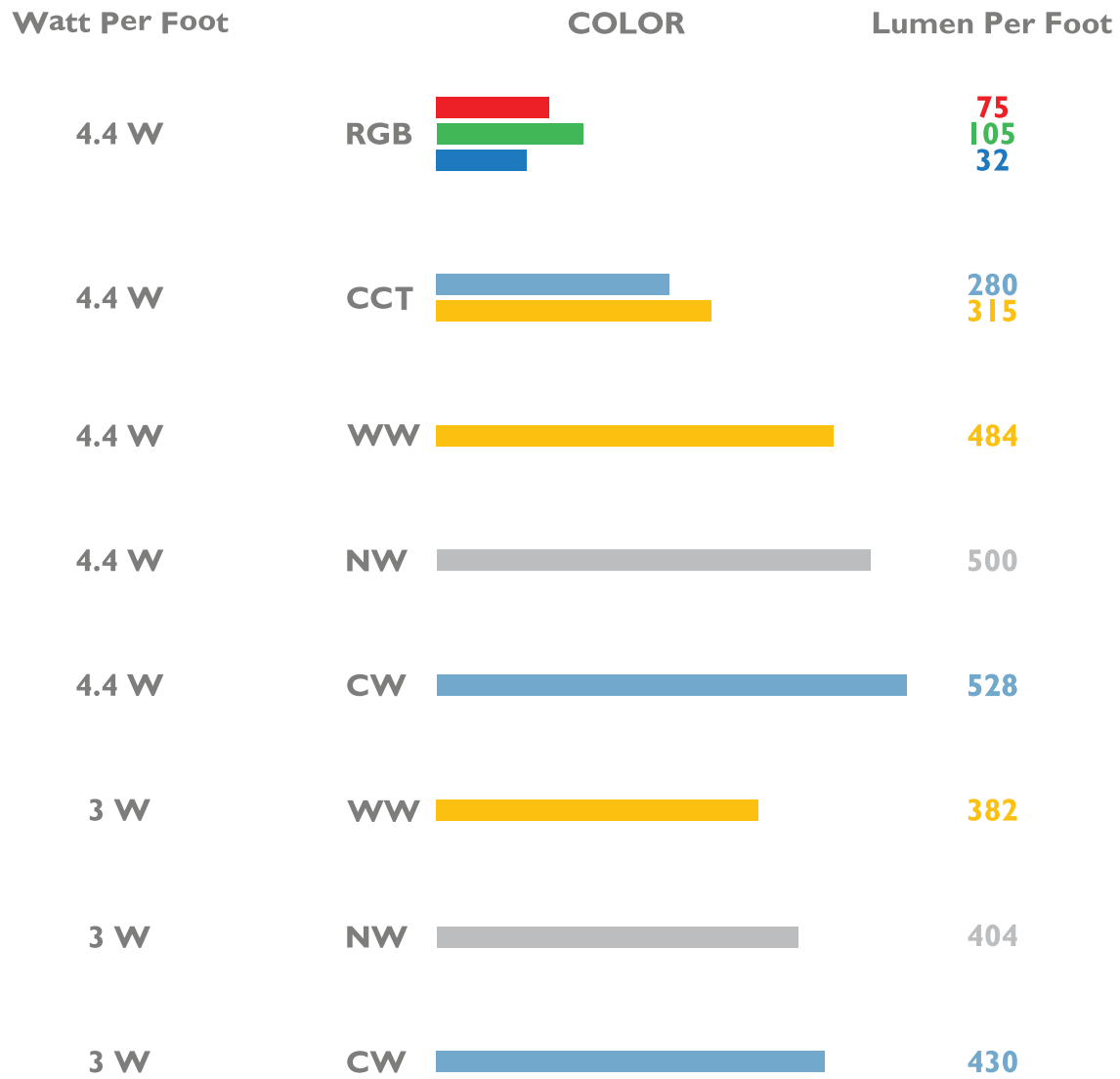

Example Installation and Layout

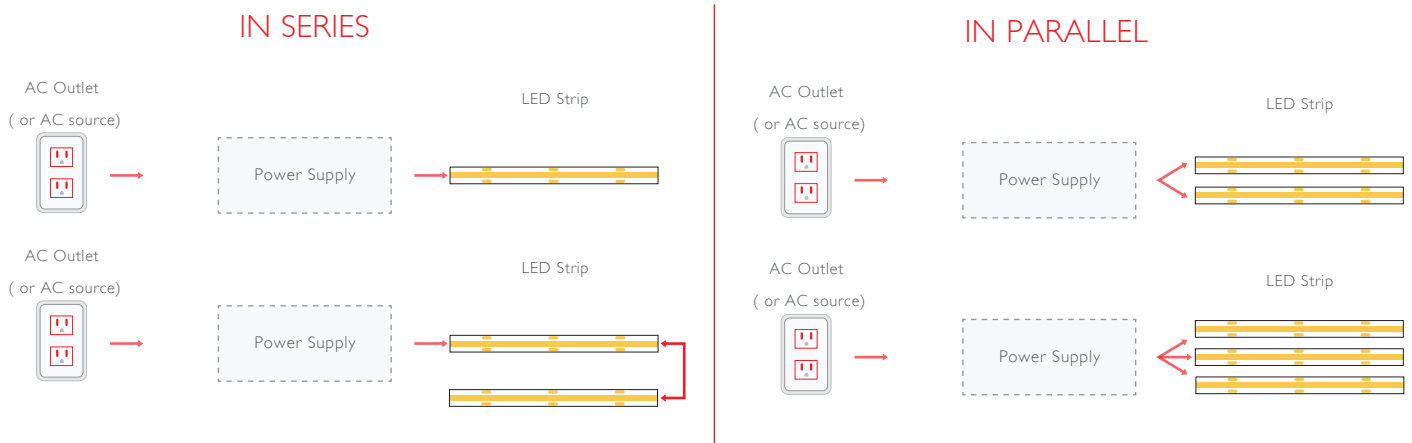

Dimming Options

In-Line Dimming

A = Toggle switching



B = Line voltage dimming

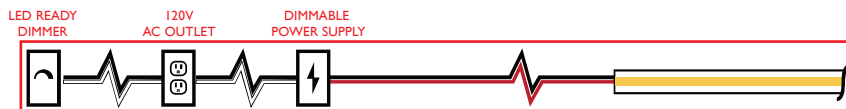

C = Low voltage dimming

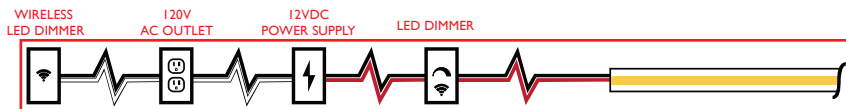

D = Automotive and marine



SSL Connectors (Coupler)

▶ SSL Cut Strip to Wire Connector



SKU: CONN-CLP-SSL-10mm-CLP
5 amp rating
Operates on 12v - 24v DC.

SSL Connectors (Bare Connector)

▶ SSL 2 Pin Bare Wire Connector

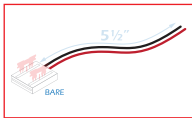

SKU: CONN-CLP-SSL-10mm-BARE
5 amp rating

SSL Connectors (Extender)

▶ SSL 2 Pin Extension Connector

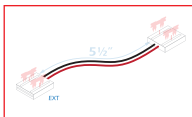

SKU: CONN-CLP-SSL-10mm-EXT
5 amp rating

Strip Light Connectors (Bare Wire)

▶ 2 Pin Bare Wire



Wire Size: 18AWG, 20AWG
Wire Length: 25ft
5 amp rating
Suitable for single color striplights
SKU: CONN-2PIN-BARE-20AWG-ID

▶ 3 Pin Bare Wire



Wire Size: 18AWG, 20AWG
Wire Length: 25ft
Suitable for RGB color changing striplights
5 amp rating
SKU: CONN-3PIN-BARE-18AWG-ID
SKU: CONN-3PIN-BARE-20AWG-ID

▶ 4 Pin Bare Wire



Wire Size: 18AWG, 20AWG
Wire Length: 25ft
Suitable for RGB color changing striplights
5 amp rating
SKU: CONN-4PIN-BARE-18AWG-ID
SKU: CONN-4PIN-BARE-20AWG-ID

Strip Light Connectors (Quick Connectors)

▶ Single Pin Connector with Bare Wire – Female Connector



Bare wire female connector can connect directly to power adaptors.
5 amp rating
SKU: CONN-1PIN-FML-BARE(Lock)

▶ Single Pin Connector with Bare Wire – Male Connector



Bare wire female connector can connect directly to striplight controllers.
5 amp rating
SKU: CONN-1PIN-ML-BARE(Lock)

▶ Female Connector 1 Pin Terminal



Female terminal connector can connect directly to power adaptors.
5 amp rating
SKU: CONN-1PIN-TRMNL-FML



▶ Male Connector 1 Pin Terminal





Male terminal connectors can connect directly to striplight controllers.
5 amp rating
SKU: CONN-1PIN-TRMNL-ML

Power Adapters (24W, 60W, 100W)

▶ Outdoor Power Supply 0-10V dimming- 24V Output

		DC Output Voltage	Power Supply Watt	SKU
		24V	100W	PWR-010V-100W-24V-OD
		24V	200W	PWR-010V-200W-24V-OD

▶ Outdoor Phase/Triac Dimmable Power Supply – 24V DC Output

			DC Output Voltage	Power Supply Watt	SKU
			24V	80W	PWR-DIM-NUR-24V-80W-OD
			24V	100W	PWR-DIM-NUR-24V-100W-OD
			24V	200W	PWR-DIM-NUR-24V-200W-OD
			12V/24V	300W	PWR-5INI-300-12V/24V-OD

▶ Indoor Phase Dimming Power Supply – 24V DC Output

		DC Output Voltage	Power Supply Watt	SKU
		24V	25W	PWR-DIM-NUR-24V-25W-ID
		24V	50W	PWR-DIM-NUR-24V-50W-ID

▶ Junction Box (25W, 50W, 100W, 200W)

				Junction Box Watt	SKU
				25W	PWR-JB-25
				50W	PWR-JB-50
				100W	PWR-JB-100
				200W	PWR-JB-200

▶ MAGNITUDE Dimmable Driver (20-300W) – 24VDC Output

	DC Output Voltage	Power Supply Watt	SKU
	24V	20W	PWR-DIM-DRV-24V-20W
	24V	60W	PWR-DIM-DRV-24V-60W
	24V	100W	PWR-DIM-DRV-24V-100W
	24V	200W	PWR-DIM-DRV-24V-200W
	24V	300W	PWR-DIM-DRV-24V-300W

Power Supply (Non-Dimmable)

▶ Meanwell Power Supply-Outdoor Rated 12VDC or 24VDC

	DC Output Voltage	Power Supply Watt	SKU
	24V	100W	PWR-DRV-24V-100W-OD-MW

Compatible Aluminum Extrusions

▶ Aluminium Extrusions Suspended O-1818

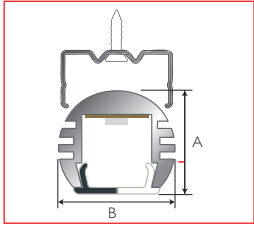

A: 1 1/16" or 0.68" ~16.6mm
 B: 7/32" or 0.47" ~11.2mm
 SKU: AE-1818-Suspended O-1M
 SKU: AE-1818-Suspended O-2M

▶ Aluminum Extrusion Recessed – Mini Step 082

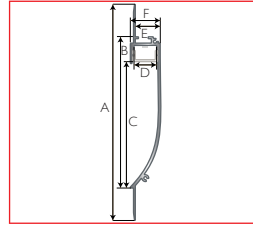

A: 5 1/4" or 5.27" ~133.8mm
 B: 3 1/16" or 3.69" ~93.8mm
 C: 33/32" or 3.08" ~78.3mm
 D: 9/16" or 0.55" ~13.9mm
 E: 5/8" or 0.61" ~15.5mm
 F: 3/4" or 750" ~18.05
 SKU: AE-ALP082-Recessed-Mini-Step-2M

▶ Aluminum Extrusion Recessed Mount – 087

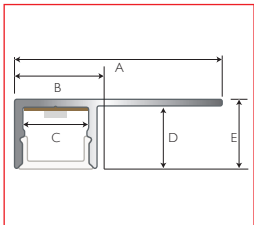

A: 15/13" or 1.30" ~33.1mm
 B: 1/2" or 0.52" ~13.1mm
 C: 7/16" or 0.41" ~10.5mm
 D: 3/8" or 0.39" ~10mm
 E: 7/16" or 0.43" ~11mm
 SKU: AE-087-AP-REC-2M

▶ Aluminum Extrusions Quarter Round-1616

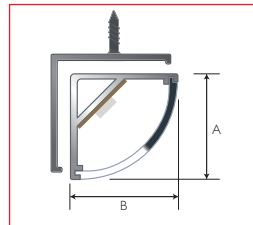

A: 5/8" or 0.62" ~16mm
 B: 5/8" or 0.62" ~16mm
 SKU: AE-BK-1616-QRound-2M
 SKU: AE-1616-Quarter Round-2M
 SKU: AE-1616-Quarter Round-1M

▶ Aluminum Extrusions Deep Flange-A035

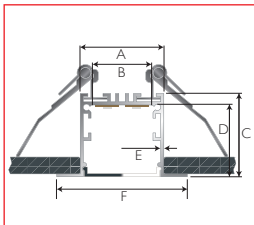

A: 1 3/8" or 1.375" ~35mm
 B: 1" or 1.00" ~25mm
 C: 1 1/4" or 1.25" ~31.75mm
 D: 1 3/8" or 1.375" ~35mm
 E: 1/16" or .06" ~1.2mm
 F: 0.63" ~55mm
 SKU: AE-A035-Deep Flange-2M

▶ Round Surface Baseboard-18mm

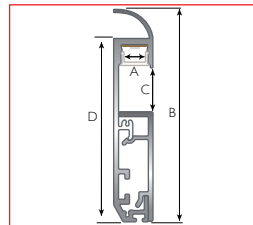

A: 7/16" or 0.43" ~10.5mm
 B: 35/16" or 3.3" ~84mm
 C: 1 1/16" or .6875" ~17.46
 D: 23/4" or 2.72" ~69mm
 SKU: AE-SK1580-18-Surface Baseboard-2M

▶ Aluminum Extrusions Recessed Mount –086

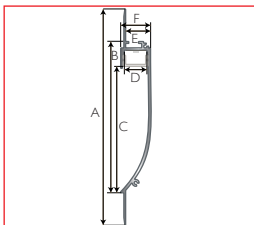

A: 5 1/4" or 5.27" ~133.8mm
 B: 3 1/16" or 3.69" ~93.8mm
 C: 33/32" or 3.08" ~78.3mm
 D: 9/16" or 0.55" ~13.9mm
 E: 5/8" or 0.61" ~15.5mm
 F: 3/4" or 750" ~18.05
 SKU: AE-ALP086-Recessed-Step-2M

▶ Recessed Baseboard-18mm

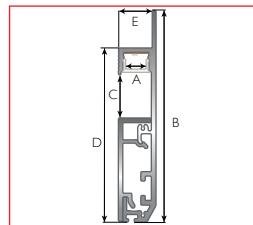

A: 7/16" or 0.43" ~10.5mm
 B: 35/16" or 3.3" ~84mm
 C: 1 1/16" or .6875" ~17.46
 D: 23/4" or 2.72" ~69mm
 E: 9/16" or .5625" ~14.8mm
 SKU: AE-SK1580TR-18-Recessed Baseboard-2M

▶ Aluminum Extrusions Universal Slim-1506

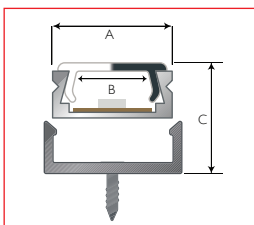

A: 5/8" or 0.62" ~15.21mm
 B: 3/16" or 0.1875" ~5.22mm
 C: 1/4" or 0.250" ~7.04mm
 SKU: AE-AE-BK-1506-Uni Slim-1M
 SKU: AE-1506-Uni Slim-1M
 SKU: AE-1506-Uni Slim-2M

▶ Aluminum Extrusions Double Wide Slim-2310

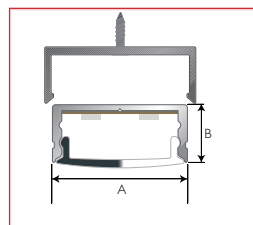

A: 15/16" or .93" ~23.62mm
 B: 3/8" or .37" ~10.4mm
 SKU: AE-2310-Double Wide Slim-2M

▶ Aluminum Extrusions Recessed – Universal Wide 071

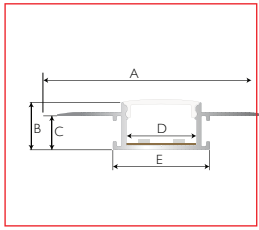

A: 2 1/2" or 2.50"~61.50mm
 B: 9/16" or .56"~14.29mm
 C: 3/8" or .37"~9.53mm
 D: 1 3/16" or 0.81"~20.64mm
 E: 1 1/8" 1.13 28.70
 SKU:AE-ALP071-Recessed-Uni-Wide-2M

▶ Aluminum Extrusions Flat-1201

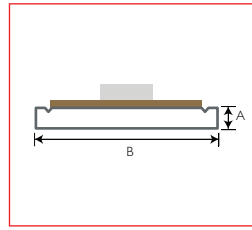

A: 5/8" or 0.62"~15.88mm
 B: 5/8" or 0.62"~15.88mm
 SKU:AE-1201-Flat-1M

▶ Aluminum Extrusions Hanger-R003

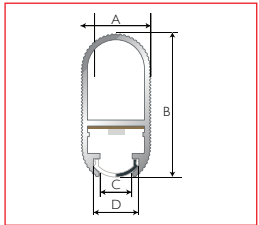

A: 9/16" or 0.56"~14.29mm
 B: 1 1/4" or 1.25"~31.75mm
 C: 5/16" or .31"~ 7.94mm
 D: 3/8" or 0.37"~9.53"
 SKU:AE-R003-Hanger-1M

▶ Aluminum Extrusions Recessed- Mud in Crown I28

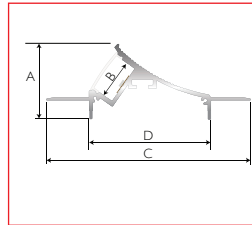

A: 1 3/8" or 1.37"~34.93mm
 B: 3/4" or .75" 19.05mm
 C: 3 3/4" or 3.7"~95.7mm
 D: 2 3/8" or 22.3"~56.8mm
 SKU:AE-ALP128- Mud-In-Crown-2M

▶ Aluminum Extrusions Wide-Flange-055

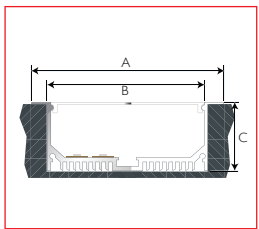

A: 3 1/2" or 3.50"~88.90mm
 B: 2 7/8" or 2.95"~74.93mm
 C: 1 1/4" or 1.25"~31.75mm
 SKU:AE-055-Wide Flange-2M

▶ Aluminum Extrusions Recessed – Inside Corner 069

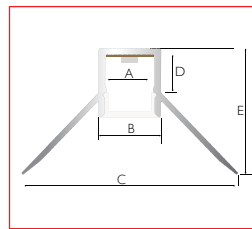

A: 3/8" or .37"~9.53mm
 B: 1/2" or .50"~12.70mm
 C: 1 3/4" or 1.75"~ 44.45mm
 D: 5/16" or 0.31"~7.94mm
 E: 1 1/16" or 1.00"~26.99mm
 SKU:AE-ALP069-Recessed-Inside-Corner-2M

▶ Aluminum Extrusions Universal Wide-1715

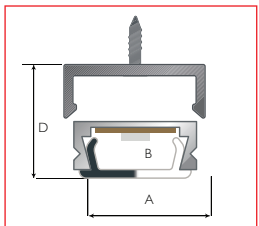

A: 1 1/16" or .68"~17.46mm
 B: 1/2" or .50"~12.70mm
 C: 5/8" or .62"~15.88mm
 SKU:AE-BK-1715-Uni Wide-2M
 SKU:AE-1715-Uni Wide-1M

▶ Aluminum Extrusions Universal-1612

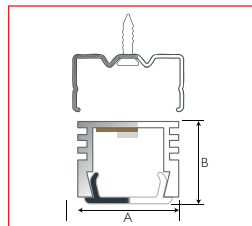

A: 5/8" or .625"~15.88mm
 B: 1/2" or .500"~12.70mm
 SKU:AE-1612-Uni-2M
 SKU:AE-1612-Uni-1M

▶ Aluminum Extrusions Up Down-040L

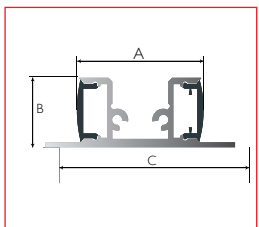

A: 1 1/4" or 1.25"~ 31.75mm
 B: 1 1/16" or .68"~17.46mm
 C: 1 29/32" or 1.90"~48.6mm
 SKU:AE-040L-Up Down-2M

▶ Aluminum Extrusions Recessed – Outside Corner 070

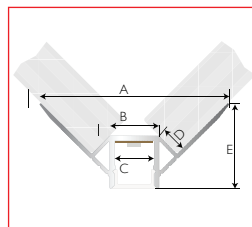

A: 2" or 2.0"~50.80mm
 B: 1/2" or .50"~12.70mm
 C: 3/8" or .37"~ 9.53mm
 D: 1/4" or .25"~ 6.35mm
 E: 7/8" or 0.87"~ 22.23mm
 SKU:
 AE-ALP070-Recessed-Outside-Corner-2M

▶ Bendable Aluminium Channel



SKU:AE-I806-BEND-2M
 Bending Radius of 6 inches

▶ Aluminum Extrusions Recessed-Wide Smooth 110

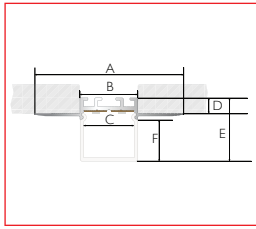

A: 2 1/2" or 2.50" ~ 63.50mm
 B: 1" or 1.00" ~ 25.40mm
 C: 7/8" or .875" ~ 22.23mm
 D: 5/16" or .31" ~ 7.94mm
 E: 1 1/8" or 1.13" ~ 28.70mm
 F: 3/4" or .75" ~ 19.05mm
 SKU:
 AE-ALP110-S-Recessed-Wide-Smooth-2M

▶ Aluminum Extrusions Shelf-044a

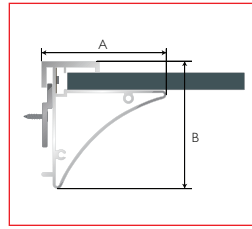

A: 2 1/4" or 2.25" ~ 57.15mm
 B: 2 1/4" or 2.25" ~ 57.15mm
 SKU:AE-044A-Shelf-2M

▶ Aluminum Extrusions Smooth Round-2623

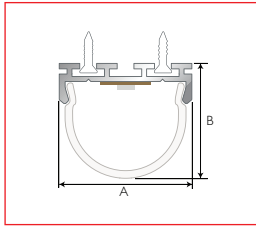

A: 1 1/8" or 1.13" ~ 28.70mm
 B: 7/8" or .875" ~ 22.23mm
 SKU:AE-2623-Smooth Round-2M

▶ Aluminum Extrusions Smooth Square-2114

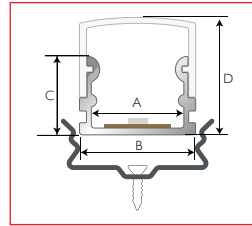

A: 5/8" or .625" ~ 15.88mm
 B: 13/16" or .81" ~ 20.64mm
 C: 9/16" or .56" ~ 14.29mm
 D: 13/16" or .81" ~ 20.64mm
 SKU:AE-2114-Smooth Square-2M

▶ Aluminum Extrusions Smooth Track-011

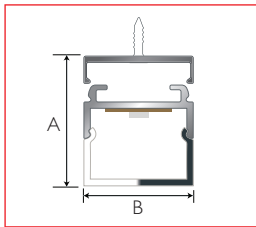

A: 3/4" or .75" ~ 19.05mm
 B: 3/4" or .75" ~ 19.05mm
 SKU:AE-011-Smooth Track-2M

▶ Aluminum Extrusions Double Cove-090

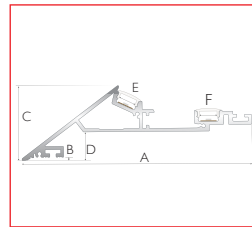

A: 5 3/4" or 5.7" ~ 146mm
 B: 1/8" or .125" ~ 3.18mm
 C: 1 3/4" or 1.75" ~ 46mm
 D: 3/4" or .75" ~ 19.05mm
 E: 1/2" or .50" ~ 12.70mm
 F: 1/2" or .50" ~ 12.70mm
 SKU:AE-ALP090-Double-Cove-2M

▶ Aluminum Extrusions Surface-Square 068

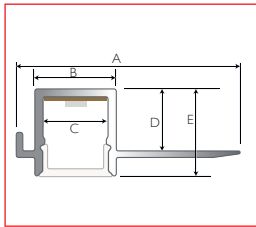

A: 1 3/8" or 1.37" ~ 34.93mm
 B: 1/2" or .500" ~ 12.70mm
 C: 3/8" or .375" ~ 9.53mm
 D: 3/8" or .375" ~ 9.53mm
 E: 9/16" or .56" ~ 14.29mm
 SKU:AE-ALP068-Recessed-Universal-2M

▶ Aluminum Extrusions Universal Recessed-2212

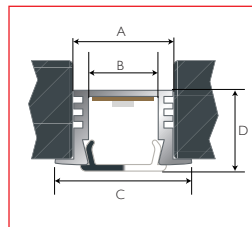

A: 5/8" or .62" ~ 15.88mm
 B: 7/16" or .43" ~ 11.11mm
 C: 7/8" or .87" ~ 22.23mm
 D: 1/2" or .50" ~ 12.70mm
 SKU:AE-2212-Uni-Rec-1M

▶ Aluminum Extrusions Universal Slim Recessed-2206

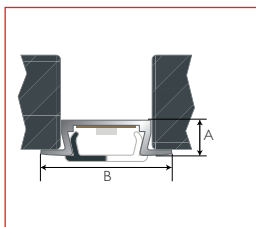

A: 5/16" or 0.31" ~ 7.94mm
 B: 7/8" or 0.87" ~ 22.23mm
 SKU:AE-2206-Uni Slim-Rec-1M

▶ Aluminum Extrusions Universal Wide Slim-1706

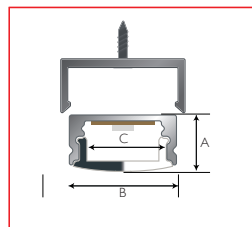

A: 1/4" or 0.250" ~ 6.35mm
 B: 1 1/16" or 0.68" ~ 17mm
 C: 7/16" or 0.43" ~ 11.11mm
 SKU:AE-1706-Uni Wide Slim-1M)

Remotes

▶ Milight Remote Holder



* Holder for MiLight remote control.
SKU: MILI-REM HOLDER

▶ Milight Color Balance Remote



* 4 zone warm white to cool white color changing remote.
SKU: MILI-REM-CB

▶ Milight RGB Remote



* 4 zone RF RGBW color changing remote.
SKU: MILI-REM-RGBW

▶ Milight RGBWW Remote



* 4 zone RF RGBW color changing remote.
SKU: MILI-REM-RGBWW

▶ 8 Zone RGB+CCT Remote Controller

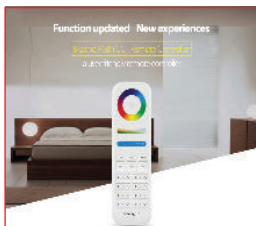

* Working Temperature: -4°F to 140°F
(-20°C to 60°C)
* Voltage: 3V(2*AAA Battery)
* Transmission Frequency: 2400-2483.5MHz
* Modulation Method: GFSK
* Transmitting Power: 6dBm
* Control Distance: 30m
* Standby Power: 15uA
SKU: MILI-REM-RGBWW-8Z

Panel Remote Controller

▶ 4-Zone Brightness Dimming Smart Panel Remote Controller



* Working Temperature: -4°F to 140°F
(-20°C to 60°C)
* Voltage: 3V(2*AAA Battery)
* Transmission Frequency: 2400-2483.5MHz
* Modulation Method: GFSK
* Transmitting Power: 6dBm
* Control Distance: 30m
* Standby Power: 15uA
SKU: MILI-REM-DIM-4Z (Panel)

▶ 4 Zone RGB+CCT Smart Panel

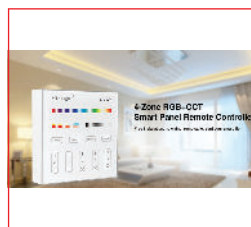

SKU: MILI-REM-RGBWW-WALL-4Z

▶ 8 Zone Smart Panel Remote Controller



* Working Temperature: -4°F to 140°F (-20°C to 60°C)
* Voltage: 3V(2*AAA Battery) / DC3.3V
* Transmission Frequency: 2400-2483.5MHz
* Transmitting Power: 6dBm
* Control Distance: 30m
* Panel Size: 4.17in. x 5.75in. x 0.79in. (106mm x 146mm x 20mm)
SKU: MILI-REM-RGBWW-WALL-8Z

MiBoxer® Controller & Amplifier

▶ 4 Channel High Speed Amplifier



- * Power twice as many LEDs in your project with the amplifier
- * Compatible with all PWM series LED controllers in market
- * Input Voltage: 12V/24V DC
- SKU: MILI-CONT-AMP

▶ 5 IN 1 Smart LED Controller



- * 2.4GHz remote and smartphone control
- * Compatible with single color; CCT, RGB, RGBW and RGB+CCT output mode
- * Input Voltage: 12-24V DC
- * SKU: MILI-CONT-RGBCB-STP

▶ WiFi Controller Bridge – 2.4GHz Gateway



- * Adjust ON/OFF, brightness, color temperature and change light colors through voice command.
- SKU: MILI-WIFI-BRIDGE-G2

▶ Single Color LED Strip Light Controller



- * 2.4GHz remote control and App control
- * Compatible with single color output modes
- * Input Voltage: 12-24V DC
- SKU: MILI-CONT-G2-DIM-STP

▶ Dual White (CCT) LED Strip Controller



- * 2.4GHz remote control and App control
- * Color temperature adjustable from warm white to cool white, dimmable control
- SKU: MILI-CONT-G2-CCT-STP

▶ RGB LED Strip Controller



- * 2.4GHz remote control and App control
- Mix Red, Green and Blue light to adjust color temperature.
- SKU: MILI-CONT-G2-RGB-STP

▶ RGBW LED Strip Controller



- * 2.4GHz remote control and App control
- * 16 million colors to choose from
- * Input Voltage: 12-24V DC
- SKU: MILI-CONT-G2-RGBW-STP

▶ 2 in 1 Controller (Single color; dual white)

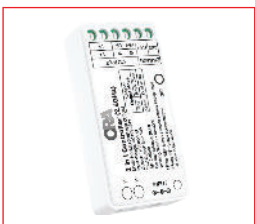

- * 2.4GHz remote control and App control
- * CCT adjustable
- * Input Voltage: 12-24V DC
- SKU: MILI-CONT-2IN1-CCT-DIM

▶ 3 in 1 Controller (RGB, RGBW, RGB+CCT)

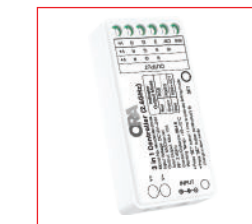

- * 2.4GHz remote control and App control
- * 16 million colors to choose from
- * Input Voltage: 12-24V DC
- SKU: MILI-CONT-3IN1-CCT-DIM

Sun Richer[®] Controller

▶ 5A 4-Channel 12-36V Constant Voltage RF LED Strip Dimmer Controller

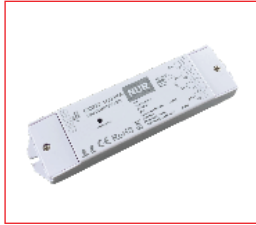

- * Constant voltage LED strip dimmer controller
- * Input Voltage: 12-36V DC
- * Suitable for single color, dual color and RGB/RGBW lights.
- SKU: CONT-SR-1009FA

▶ RF and WiFi RGBW Wall Mounted Touch Panel LED Controller



- * User-friendly interface, easy and simple operation
- * Operation return function
- * Control 1 zone, each zone can be set endless receivers, each receiver maximally be controlled by 8 different remotes
- * Preset 10 changing modes, with pause function
- SKU: CONT-SR-2820S-US

▶ RF and Wi-Fi rotary LED Dimmer



- * Rotary dimmer controller which offers both switch and smooth brightness dimming functions for single color LED lighting.
- SKU: CONT-SR-2836DIM-US

▶ RF and WiFi RGB Controlle



- * LED rotary dimmer switch which offers switch, brightness dimming and color tone adjustment functions
- SKU: CONT-SR-2836-RGB-US

Safety And Disclosures

Installation must be in accordance with NFPA 70®, National Electrical Code® (NEC®)

To ensure safety and correct installation, our strips are intended to be installed by a qualified, licensed electrician.

Only install with a Class 2 DC Constant Voltage LED driver to meet UL requirements.

Do not install in environment where excessive heat may exist.

LED strip lights must be handled with care. Excessive handling, bending, and pressure may damage the product, voiding the warranty.

Do not install indoor LED tape light products in outdoor / wet location environments. Only use copper wiring. Use wires rated for at least 176°F (80°C) and certified for use with external connection of electrical equipment.

Each maximum run requires a dedicated power feed from the driver. Do not extend beyond the recommended maximum run length.

Make sure the appropriate gauge wire is installed between driver, LEDs, and any dimmers. When choosing wire, calculate voltage drop, maximum amperage rating, and the location ratings on the wire. Improper wire selection and installation could overheat wires, and cause fire.

Do not modify the product beyond the instructions or the warranty will be void.

We reserve the right to modify and improve the design of our fixtures without prior notice. Although we try our best to order the same colors every time, due to changes in technology and phosphors over time, we cannot guarantee to match existing installed fixtures for subsequent orders or replacements in regards to product appearance, CCT, or lumen output.

Warranty Information

Lighting Product Warranty

In the event that any product is found to have a manufacturer's defect within the warranty period, LED City® will, at their discretion, repair or replace the defective product/part, or refund the amount paid for the product. The warranty period is based upon the product and becomes effective from the date of shipment or invoice. The warranty does not cover aesthetic degradation of the product.

This warranty is void if:

1. The product was operated or stored in abnormal use or maintenance conditions.
2. The product is repaired, modified or altered in any way.
3. The product is damaged by abuse, accident, or acts of nature.
4. The product was installed improperly or incorrect voltage was applied.
5. The product casing has been opened.

The LED industry is a vast and quickly growing industry and the products are continually evolving. Aesthetic appearance of goods may change from order to order. LED City® cannot guaranty the product will look exactly the same on different orders. If a defective product is repaired or replaced, company cannot guaranty that the brightness or color temperature will match exactly the same as the other products ordered. Since the LED is newer and comes from a different manufacturing batch, color temperature and brightness may not be exactly the same. Furthermore, LED's brightness can vary depending upon levels of usage, temperature operated in, and conditions of the fixture.

Product repair, replacement or refund is LED City's® sole warranty obligation, and incidental and consequential damages are excluded. No one is authorized to make any other warranties on behalf of LED City®, or modify this warranty, except in a separate written paper document under signature of a corporate officer of LED City® then-listed with the Texas Secretary of State.

Company will not be liable for repairing damages or failures caused by acts of God, abuse, mishandling, alteration, accident, electrical current fluctuations, failure to follow operating, maintenance or environmental instructions prescribed by Company, abnormal usage, or any other use or application for which the Products are not intended. LED City® will not be liable for incidental or consequential damages connected with or in lieu of using its goods or services in respects to loss of property, damages, revenues, life or limb, personal injury, claimant's remedies will be limited only to repair or replacement of the goods equal to the cost of the non-conforming goods.