

# RGB LED FLEX NEON STRIP LIGHT

## Features:

- Product length: 32ft
- Max run: 32ft (add power every 32ft)
- 24V DC (longer runs)
- Color Changing: Red, Green, Blue (RGB)
- 3 oz of copper in each chip for heat dissipation (longer lifespan)
- Durable housing for outdoor use (IP67)
- Marked cut locations every 2" (to be sealed with silicone glue)
- Anti-UV protection



## Technical Specifications:

Input Voltage	24V DC
Maximum Length	32ft
Wattage	4.7W/ft
Ambient Temperature Range	-13 ~ +122 °F
The Temperature of Module Top	149 °F
Storage Temperature Range	-40 ~ +158 °F
Beam Angle	120°
IP Rating	IP67

## Applications:

- Can be Widely used in:
- Building Outline Decoration Lighting
  - KTV Decoration Lighting
  - Car Decoration Lighting
  - Urban Lighting and others Decoration Lighting

### Dimension:

Unit: Inch

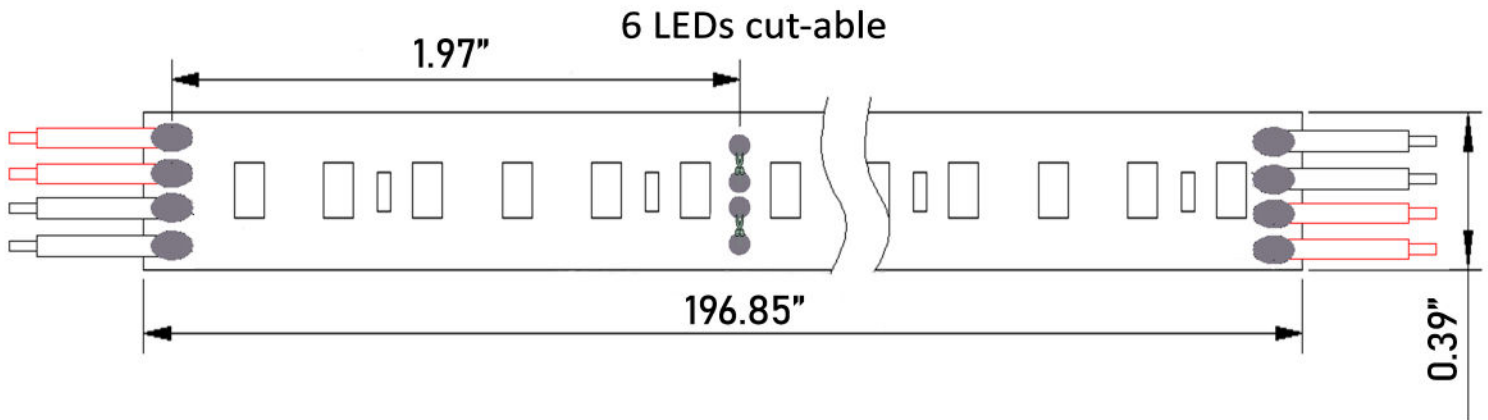

### Installation:

- \* Mounting Bracket
- \* Product installation schematic diagram

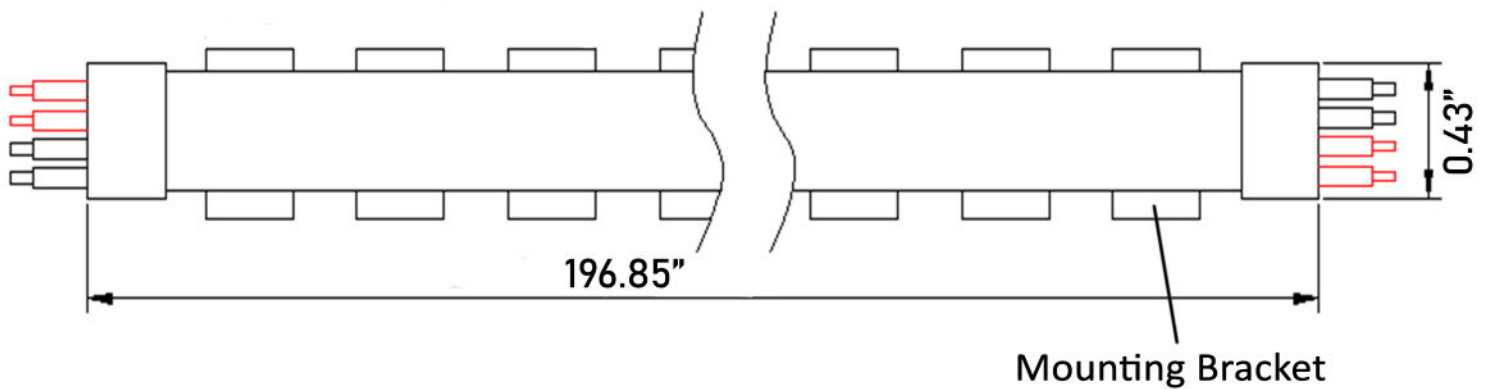

### Product Sectional Drawing:

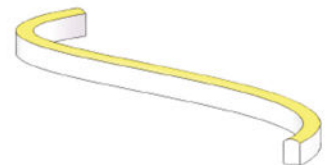
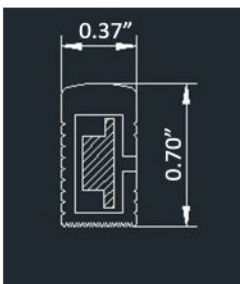

### Product Application:

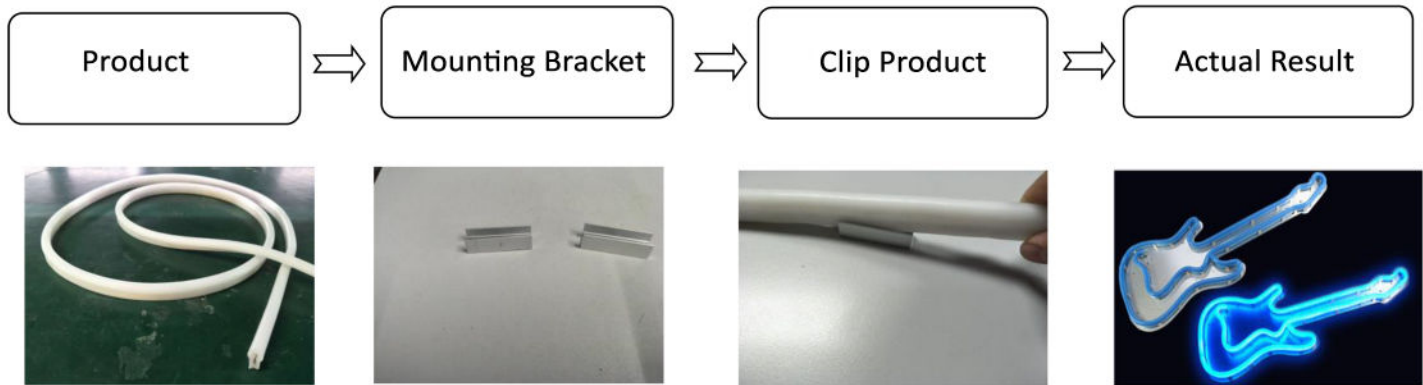

### Connect Two Products:

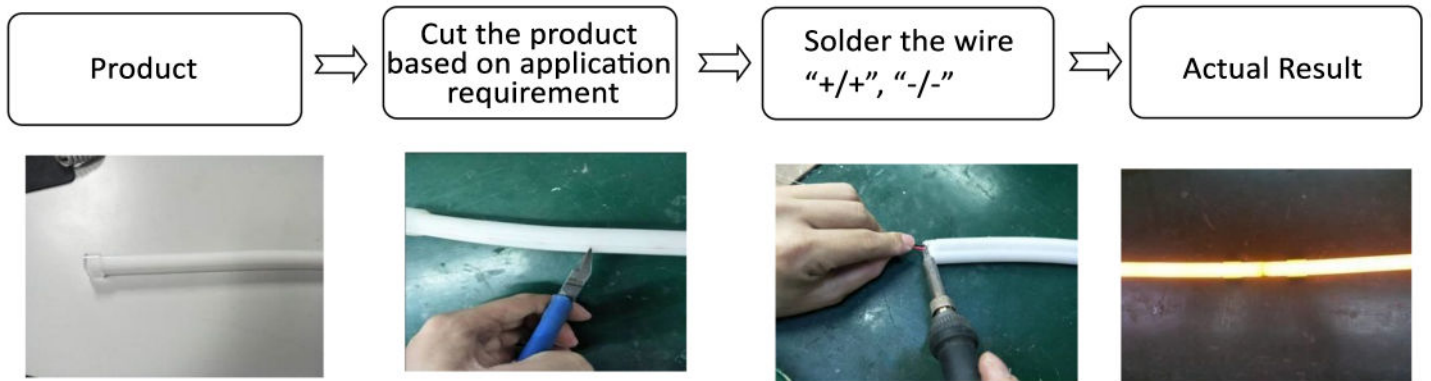

Remark: All products are standard, if actual application needs to cut the product, the cut mouth needs to be sealed by silicone glue (prohibiting acidic glue).

### Bending Direction:

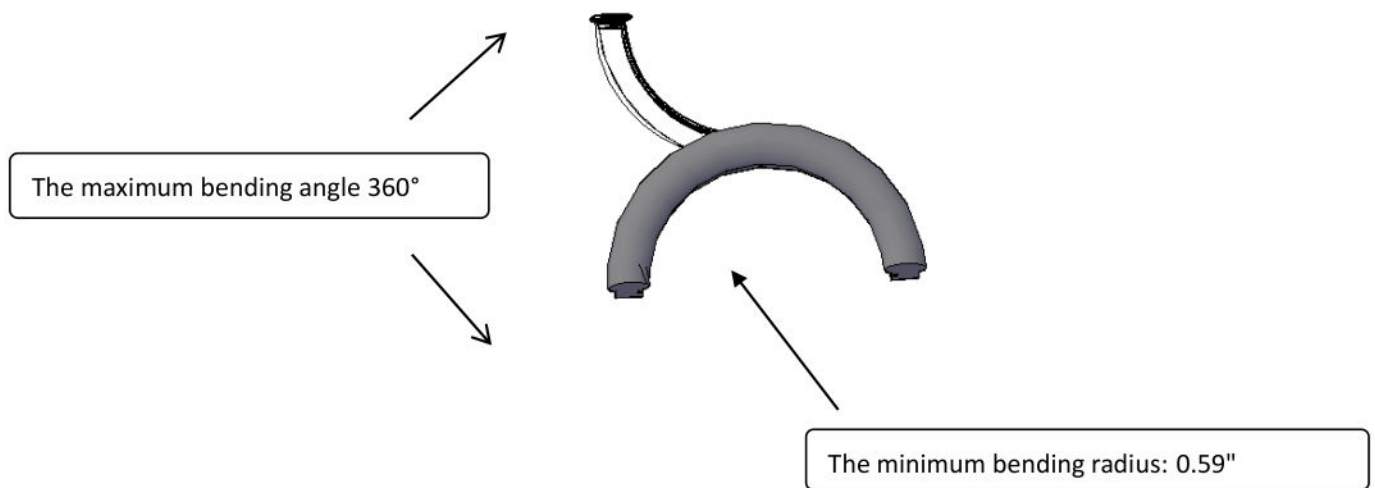

## Accessories:



### Flex Neon - End Cap

- NUR-FLEX-ACC-END CAP
- Sold separately



### Flex Neon – Mounting Bracket Clips

- NUR-FLEX-ACC-MOUNT
- Sold separately



### Flex Neon – 20M Flexible Mounting Bracket Kit

- NUR-FLEX-NS205-Bracket Kit-20M
- Sold separately



### Flex Neon – 3.3ft Straight Mounting Track Channel

- NUR-FLEX-ACC-ALU-1M
- Sold separately



### RGBW 4 Zone Remote

- MILI-REM-RGBW
- Sold separately



### RGB Strip Light Smart Controller – G3

- MILI-CONT-G3-RGB-STP
- Sold separately