

90 DEGREE TWIN SPOKE DOUBLE TENON BRACKET POLE TOP MOUNT

Description:

The Bracket is designed to mount over 2-3/8" (60mm) O.D. vertical tenon. Two fixtures can be mounted to the Round External Mount Horizontal Tenon and adjusted horizontally.



Features:

- SKU: NUR-WSD-SB2.5TW90-D
- Finish: Dark Bronze
- MAX EPA: 0.6
- Bracket is easy to install

Applications:

- Slipfitter shoebox light
- Parking lot light
- Flood light
- Other outdoor lighting fixture

Dimensions:

Unit: Inch

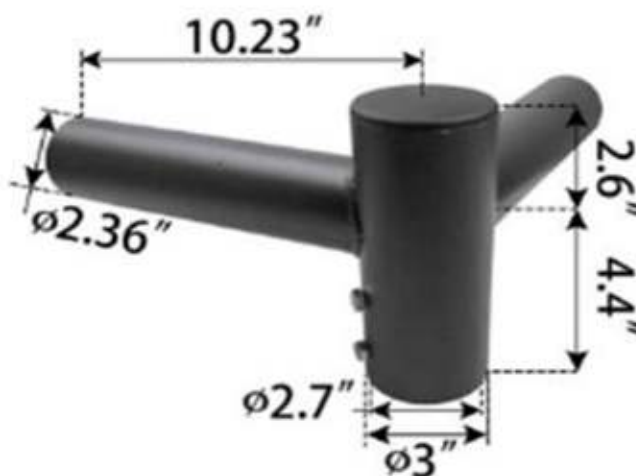

Can be used with:

Flood Light FL04:

- SKU: NUR-FL04-150W-5000K
NUR-FL04-200W-5000K
NUR-FL04-300W-5000K
- Wattage: 150W, 200W, 300W
- Input Voltage: 120-277V AC
- Color Temperature: 5000K
- Lumens: 20800lm, 26000lm, 41000lm
- Finish: Dark Bronze



Flood Light FL05:

- SKU: NUR-FL05-100W-5000K
NUR-FL05-250W-5000K
NUR-FL05-300W-5000K
- Wattage: 100W, 250W, 300W
- Input Voltage: 347-480V AC
- Color Temperature: 5000K
- Lumens: 14200lm, 35000lm, 42000lm
- Finish: Dark Bronze



Flood Light FL08:

- SKU: NUR-FL08-45W-5000K-KM
NUR-FL08-100W-5000K-SF
NUR-FL08-100W-5000K-YK
- Wattage: 45W, 100W
- Input Voltage: 120-277V AC
- Color Temperature: 5000K
- Lumens (45W): 5650lm
- Lumens (100W): 13300lm
- Finish: Dark Bronze



Flood Light FL11:

- SKU: NUR-FL11-65W-CCT-KM
NUR-FL11-120W-CCT-SF
NUR-FL11-120W-CCT-YK
- Wattage: 65W, 120W
- Input Voltage: 120-277V AC
- Color Temperature: CCT Adjustable
- Lumens (65W): 9200lm, 17500lm
- Lumens (120W): 9400lm, 18000lm
- Finish: Dark Bronze



SWAN LED Post:

- SKU: NUR-AL-SWAN-70W-4000K
- Wattage: 70W
- Input Voltage: 100-277V AC
- Color Temperature: 4000K
- Lumens: 9100lm

